

Feature

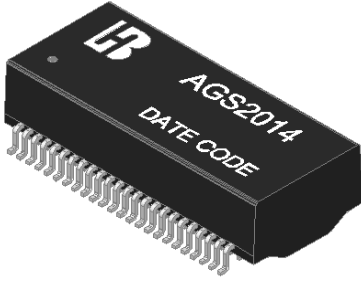

- Design for 2.5G ethernet application.
- Unsupported POE application
- Complying with ROHS & Halogen Free requirements.
- Operating temperature range: 0°C to +70°C.
- Storage temperature range: -25°C to +85°C.

Electrical Specifications @ 25°C

Part Number	Turns Ratio (±5%)		OCL (uH Min) @100KHz/0.1V	L.L (uH Max)	C _{ww} (pF Max)	DCR (Ω Max)	HI-POT
	TX	RX					
AGS2014	1CT:1CT	1CT:1CT	180	0.5	28	0.9	AC1500V/1mA

Continue

Part Number	Insertion Loss (dB Max)		Return Loss (dB Min)@Load 100Ω			
	1-100MHz	125MHz	1-40MHz	60MHz	100MHz	125MHz
AGS2014	-1.0	-1.5	-16	-14.23	-12.02	-11.05

Continue

Part Number	Cross talk (dB Min)				DCMR (dB Min)			
	30MHz	60MHz	100MHz	125MHz	1-30MHz	60MHz	100MHz	125MHz
AGS2014	-39	-33.89	-30.07	-30	-48	-42.47	-38.22	-36.35

Schematic

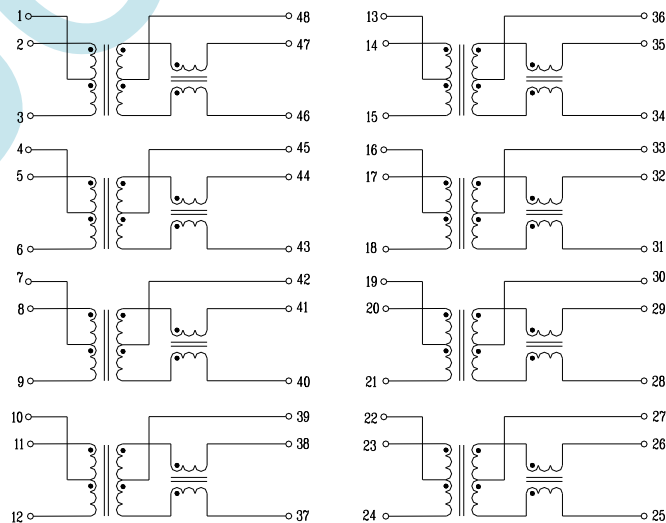

Mechanical

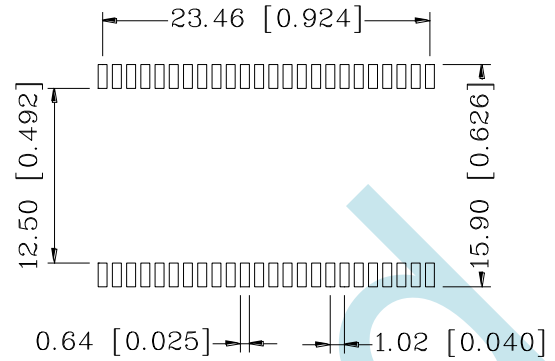
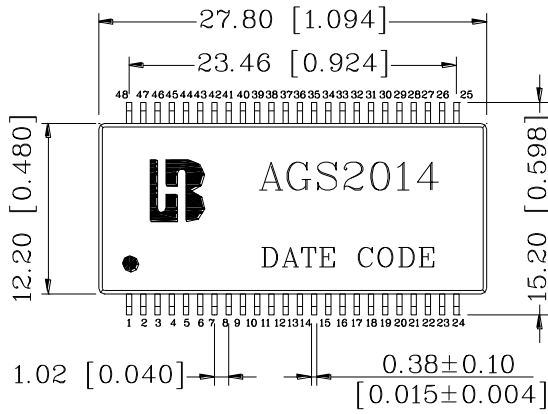

SUGGESTED PAD LAYOUT

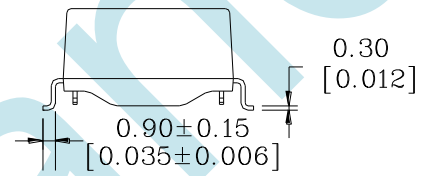
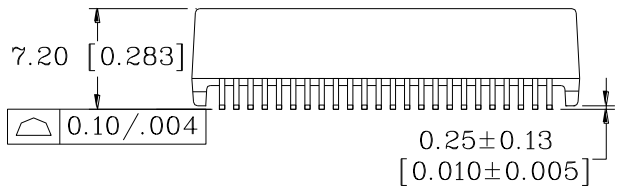

Units: mm [Inches] Tolerance: xx.xx ± 0.25 [0.010]
 0.xx ± 0.05 [0.002]

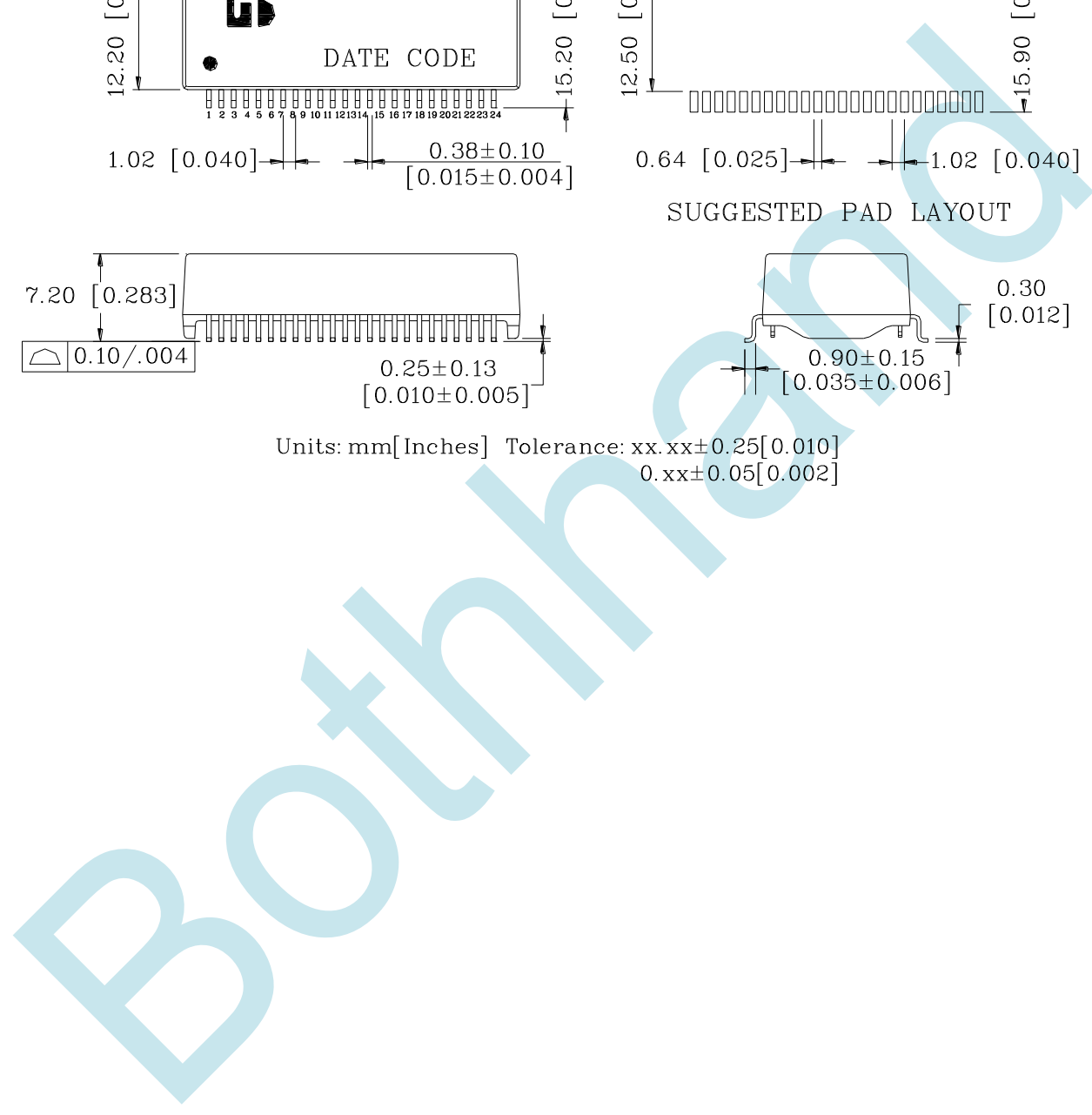

REEL PACKAGE

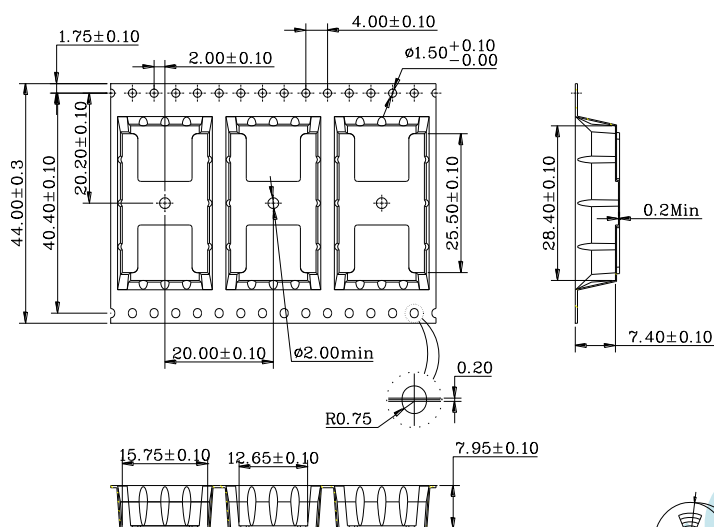

1. 10 sprocket hole pitch cumulative tolerance ±0.20
2. Carrier camber is within 1 mm in 250mm
3. Material : Black Anti-Static polystyrene.
4. All dimensions meet EIA-481-B requirements
5. Thickness : 0.40±0.05mm
6. Component load per 13" reel : 350pcs
7. Packing length per 22" reel : 25.1 Meters
8. comply with Bothhand's <BHKP-WI-44-005> requirements

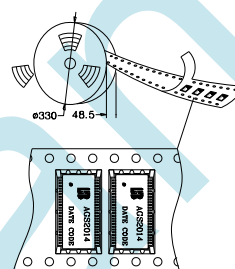

CARTON PACKAGE

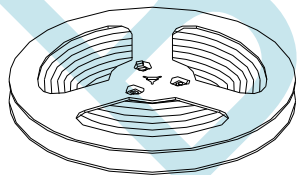

REEL

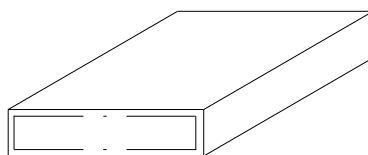

INNER BOX: 347x347x82

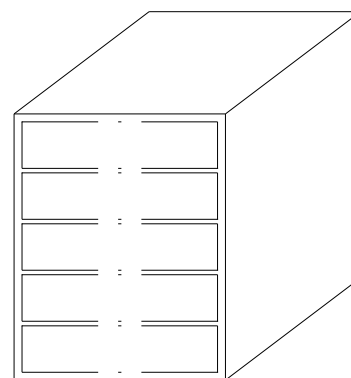

OUTER CARTON: 375x375x470

1. 1 Reel=350PCS
2. 1 INNER BOX=1 Reel=350 PCS
3. 1 OUTER CARTON=5 INNER BOX=5*350=1750 PCS